

KENWOOD

CD PLAYER

DP-M993

INSTRUCTION MANUAL

KENWOOD CORPORATION



B60-1178-00 (JA) (K,P,M,X,Y) [A]
94/12 11 10 9 8 7 6

Introduction

Your choice of this product indicates that you are a devotee to excellence in sound reproduction.

We appreciate your patronage and take pride in the long tradition of quality components that our company represents.

So that you can get the most out of your unit, we suggest that you take the time to read through this manual before you hook up and operate your system. This will acquaint you with operating features and system-connection considerations so that your listening pleasure will be enhanced right from the start.

You will notice that in all aspects of planning, engineering, styling, operating convenience and adaptability we have sought to anticipate your needs and desires.

Keep this manual handy for future reference.

For your records

Record the serial number, found on the back of the unit, in the spaces designated on the warranty card, and in the space provided below. Refer to the model and serial numbers whenever you call upon your dealer for information or service on this product.

Model _____ Serial Number _____

Unpacking

Unpack the unit carefully and make sure that all accessories are put aside so they will not be lost.

Examine the unit for any possibility of shipping damage. If your unit is damaged or fails to operate, notify your dealer immediately. If your unit was shipped to you directly, notify the shipping company without delay. Only the consignee (the person or company receiving the unit) can file a claim against the carrier for shipping damage. We recommend that you retain the original carton and packing materials for use should you transport or ship the unit in the future.

For the U.S.A.

CAUTION:

Use of controls or adjustments or performance of procedures other than those specified herein may result in hazardous radiation exposure.

In compliance with Federal Regulations, following are reproductions of labels on, or inside the product relating to laser product safety.

KENWOOD CORPORATION
SHIONOGI SHIBUYA BUILDING 17-5,
2-CHOME, SHIBUYA, SHIBUYA-KU,
TOKYO, JAPAN

KENWOOD CORP. CERTIFIES THIS EQUIPMENT
CONFORMS TO DHHS REGULATIONS NO.21 CFR
1040.10, CHAPTER I, SUBCHAPTER J.

Location: Back Panel

The marking of products using lasers (Except for some areas.)

**CLASS 1
LASER PRODUCT**

The label is attached to the rear panel and says that the component uses laser beams that have been classified as Class 1.

It means that the unit is utilizing laser beams that are of a weaker class. There is no danger of hazardous radiation outside the unit.

Accessories

- Audio cord 1
- System control cord 1

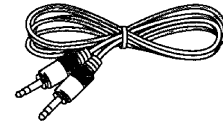
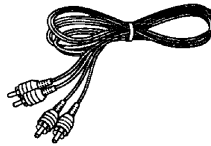

- Magazine 1
(with 6 disc trays)

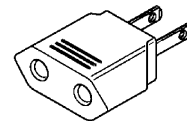
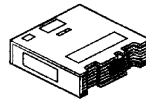

For the unit with a European AC plug in areas other than Europe. (Except for some areas)

Contents

Caution: Read the pages marked carefully to ensure safe operation.

Introduction	2	Normal playback	14
⚠ Before applying power	3	Program playback	16
⚠ Safety precautions	3	Repeated playback	18
⚠ IMPORTANT SAFEGUARDS	4	Random playback	19
Before operation	6	Editing	20
System connections	8	Timer operations	22
Controls and indicators	10	In case of difficulty	23
Before playing CDs	12	Specifications	23

Before applying power

 **Caution: Read this page carefully to ensure safe operation.**

For the U.S.A. and Canada

Important!

Units shipped to the U.S.A. and Canada are designed for operation on 120 volts AC only.

CAUTION: TO PREVENT ELECTRIC SHOCK DO NOT USE THE AC PLUG WITH AN EXTENSION CORD, RECEPTACLE OR OTHER OUTLET UNLESS THE BLADES CAN BE FULLY INSERTED TO PREVENT BLADE EXPOSURE.

For the United Kingdom

Important!

Units shipped to the U.K. are designed for operation on 240 volts AC only.

The mains plug must be removed from the wall socket prior to any internal examination.

The wires in this mains lead are coloured in accordance with the following code:

Blue Neutral
Brown Live

The wires in this mains lead must be connected to the terminals in the plug as follows:

Wire colour	Plug terminal marking
Blue	N or Black
Brown	L or Red

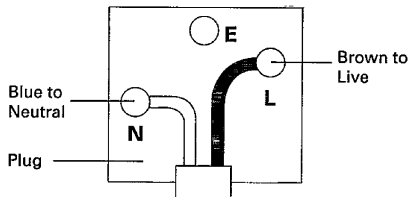

Notes:

1. If a 13-amp plug is used, this must be fitted with a 13-amp fuse.
2. If a 3-pin plug with earthing contact is used, no wire must be connected to the E terminal.

For Australia and Europe

Important!

Units shipped to Australia are designed for operation on 240 V AC only.

Units shipped to Europe are designed for operation on 230 V AC only.

For other countries

Important!

Units shipped to countries other than the above countries are equipped with an AC voltage selector switch on the rear panel. Refer to the following paragraph for the proper setting of this switch.

AC voltage selection

This unit operates on 110 - 120 or 220 - 240 volts AC. The AC voltage selector switch Type A or Type B on the rear panel is set to the voltage that prevails in the area to which the unit is shipped. Before connecting the power cord to your AC outlet, make sure that the setting position of this switch matches your line voltage. If not, it must be set to your voltage in accordance with the following direction.

AC voltage selector switch

Type A

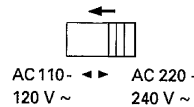

Type B

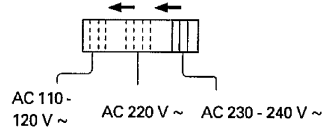





Move switch lever to match your line voltage with a small screwdriver or other pointed tool.

Note:

Our warranty does not cover damage caused by excessive line voltage due to improper setting of the AC voltage selector switch.

Safety precautions

WARNING: TO PREVENT FIRE OR ELECTRIC SHOCK, DO NOT EXPOSE THIS APPLIANCE TO RAIN OR MOISTURE.

 <div style="border: 1px solid black; padding: 5px; text-align: center;"> CAUTION <small>RISK OF ELECTRIC SHOCK DO NOT OPEN</small> </div> 	<p>CAUTION: TO REDUCE THE RISK OF ELECTRIC SHOCK, DO NOT REMOVE COVER (OR BACK). NO USER-SERVICEABLE PARTS INSIDE, REFER SERVICING TO QUALIFIED SERVICE PERSONNEL.</p>
	<p>THE LIGHTNING FLASH WITH ARROWHEAD SYMBOL, WITHIN AN EQUILATERAL TRIANGLE, IS INTENDED TO ALERT THE USER TO THE PRESENCE OF UNINSULATED "DANGEROUS VOLTAGE" WITHIN THE PRODUCT'S ENCLOSURE THAT MAY BE OF SUFFICIENT MAGNITUDE TO CONSTITUTE A RISK OF ELECTRIC SHOCK TO PERSONS.</p>
	<p>THE EXCLAMATION POINT WITHIN AN EQUILATERAL TRIANGLE IS INTENDED TO ALERT THE USER TO THE PRESENCE OF IMPORTANT OPERATING AND MAINTENANCE (SERVICING) INSTRUCTIONS IN THE LITERATURE ACCOMPANYING THE APPLIANCE.</p>

IMPORTANT SAFEGUARDS

 **Caution: Read this page carefully to ensure safe operation.**

Please read all of the safety and operating instructions before operating this unit. For best results, follow all warnings placed on the unit and adhere to the operating and use instructions. These safety and operating instructions should be retained for future reference.

- 1. Power sources** – The unit should be connected to a power supply only of the type described in the operating instructions or as marked on the appliance.
- 2. Power-cord protection** – Power-supply cords should be routed so that they are not likely to be walked on or pinched by items placed upon or against them, pay particular attention to cords at plugs, convenience receptacles, and the point where they exit from the unit.

Never pull or stretch the cord.

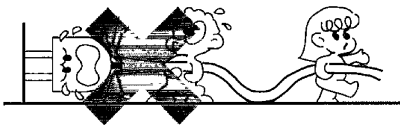

- 3. Grounding or polarization** – The precautions should be taken so that the grounding or polarization means of this unit is not defeated.
- 4. Ventilation** – The unit should be situated so that its location or position does not interfere with its proper ventilation. To maintain good ventilation, do not put records or a table-cloth on the unit. Place the unit at least 10 cm away from the walls. Do not use the unit on a bed, sofa, rug or similar surface that may block the ventilation openings.

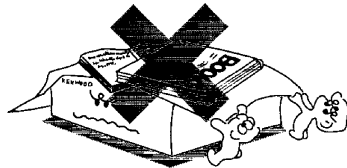

- 5. Water and moisture** – The unit should not be used near water - for example, near a bathtub, washbowl, kitchen sink, laundry tub, in a wet basement, or near a swimming pool, etc.

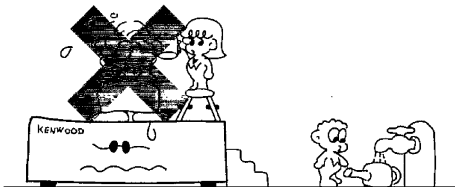

- 6. Temperature** – The unit may not function properly if used at extremely low, or freezing temperatures. The ideal ambient temperature is above +5°C (41°F).

- 7. Heat** – The unit should be situated away from heat sources such as radiators, heat registers, stoves, or other units (including amplifiers) that produce heat.

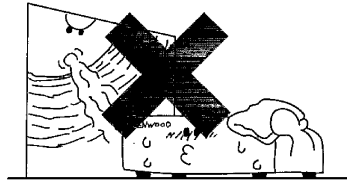

- 8. Electric shock** – Care should be taken so that objects do not fall and liquid is not spilled into the enclosure through openings. If a metal object, such as a hair pin or a needle, comes into contact with the inside of this unit, a dangerous electric shock may result. For families with children, never permit children to put anything, especially metal, inside this unit.

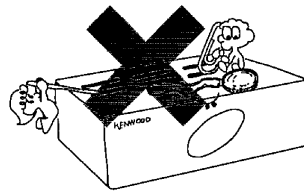

- 9. Enclosure removal** – Never remove the enclosure. If the internal parts are touched accidentally, a serious electric shock might occur.

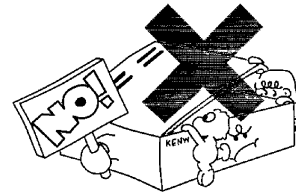

- 10. Magnetic fields** – Keep the unit away from sources of magnetic fields such as TV sets, speaker systems, radios, motorized toys or magnetized objects.

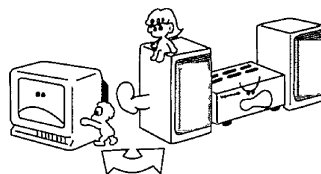

- 11. Cleaning** – Do not use volatile solvents such as alcohol, paint thinner, gasoline, or benzene, etc. to clean the cabinet. Use a clean dry cloth.

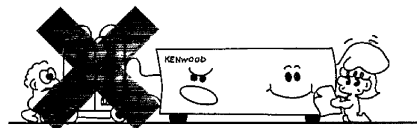

⚠ Caution : Read this page carefully to ensure safe operation.

12. Carts and stands – An appliance and cart combination should be moved with care. Quick stops, excessive force, and uneven surfaces may cause the appliance and cart combination to overturn.



13. Nonuse periods – The power cord of the unit should be unplugged from the outlet when left unused for a long period of time.

14. Abnormal smell – If an abnormal smell or smoke is detected, immediately turn the power OFF and pull out the power cord. Contact your dealer or nearest service center.

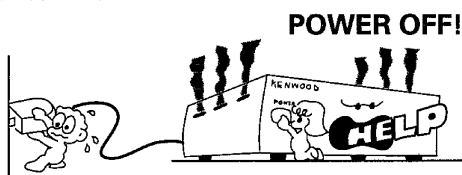

15. Damage requiring service – The unit should be serviced by qualified service personnel when:

- A.** The power-supply cord or the plug has been damaged; or
- B.** Objects have fallen, or liquid has been spilled into the unit; or
- C.** The unit has been exposed to rain; or
- D.** The unit does not appear to operate normally or exhibits a marked change in performance; or
- E.** The unit has been dropped, or the enclosure damaged.

16. Servicing – The user should not attempt to service the unit beyond that described in the operating instructions. All other servicing should be referred to qualified service personnel.

17. Outdoor antenna grounding – If an outside antenna is connected to the receiver, be sure the antenna system is grounded so as to provide some protection against voltage surges and built up static charges. Section 810 of the National Electrical Code, ANSI/NFPA 70, provides information with respect to proper grounding of the mast and supporting structure, grounding of the lead-in wire to an antenna discharge unit, size of grounding conductors, location of antenna-discharge unit, connection to grounding electrodes, and requirements for the grounding electrode. See Figure.

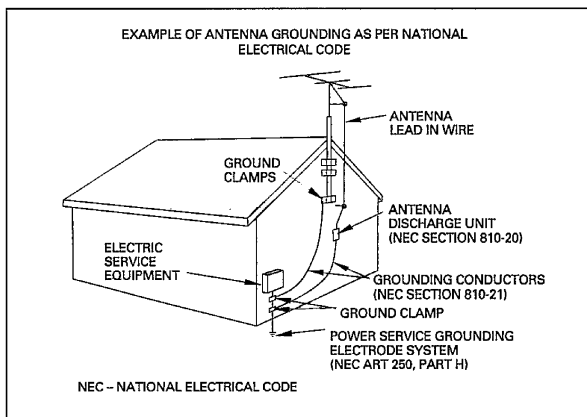

18. Power lines – An outdoor antenna should be located away from power lines.

19. AC outlets – Do not connect other audio equipment with a power consumption larger than that specified to the AC outlet on the rear panel. Never connect other electrical units, such as an iron or toaster, to it to prevent fire or electric shock.

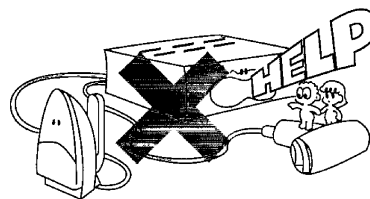

Notes:

1. Item 3 is not required except for grounded or polarized equipment.
2. Item 17 and 18 are not required except for units provided with antenna terminals.
3. Item 17 complies with UL in the U.S.A.

Before operation

Disc handling precautions

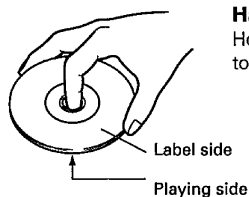

Handling

Hold compact discs so that you do not touch the playing surface.



Do not attach paper or tape to either the playing side or the label side of compact discs.

Caution on disc used

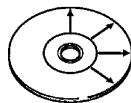

Cleaning

If fingerprints or foreign matter become attached to the disc, lightly wipe the disc with a soft cotton cloth (or similar) from the center of the disc outwards in a radial manner.

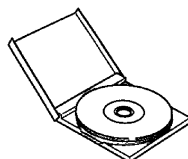

Storage

When a disc is not to be played for a long period of time, remove it from the CD player and store it in its case.

Never play a cracked or warped disc.

During playback, the disc rotates at high speed in the player. Therefore, to avoid danger, never use a cracked or deformed disc or a disc repaired with tape or adhesive agent.

Note related to transportation and movement

Before transporting or moving this unit, carry out the following operations.

1. Turn the power ON but do not load a disc or magazine.
2. Wait a few seconds and verify that the display shown appears.
3. Turn the power OFF.

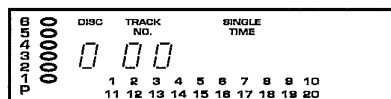

Beware of condensation

When water vapor comes into contact with the surface of cold material, water drops are produced.

If condensation occurs, correct operation may not be possible, or the unit may not function correctly.

This is not a malfunction, however, and the unit should be dried. (To do this, turn the POWER switch ON and leave the unit as it is for several hours.)

Be especially careful in the following conditions:

- When the unit is brought from a cold place to a warm place, and there is a large temperature difference.
- When a heater starts operating.
- When the unit is brought from an air-conditioned place to a place of high temperature with high humidity.
- When there is a large difference between the internal temperature of the unit and the ambient temperature, or in conditions where condensation occurs easily.

Type of disc which can be played with this unit

Disc type	Disc size
CD (general compact disc)	12 cm
CDV (CD with video) audio section	12 cm
CD single	8 cm

The 8 cm CD adaptor on sale cannot be used with this unit. If it is used with this unit, it is possible that the disc or CD player will be damaged.

- If it is required to place CD single discs using a magazine, please purchase and use the optional CDM-608 CD single disc magazine.
- In the case of CDV, the time display and music calendar display are all for the audio section only.

For CANADA

DOC REGULATION

"This digital apparatus does not exceed the CLASS B limits for radio noise emissions from digital apparatus as set out in the radio interference regulations of the Canadian Department of Communications."

For the U.S.A.

FCC WARNING:

This equipment may generate or use radio frequency energy. Changes or modifications to this equipment may cause harmful interference unless the modifications are expressly approved in the instruction manual. The user could lose the authority to operate this equipment if an unauthorized change or modification is made.

NOTE:

This equipment has been tested and found to comply with the limits for a Class B digital device, pursuant to Part 15 of the FCC Rules. These limits are designed to provide reasonable protection against harmful interference in a residential installation. This equipment may cause harmful interference to radio communications, if it is not installed and used in accordance with the instructions. However, there is no guarantee that interference will not occur in a particular installation. If this equipment does cause harmful interference to radio or television reception, which can be determined by turning the equipment off and on, the user is encouraged to try to correct the interference by one or more of the following measures:

- Reorient or relocate the receiving antenna.
- Increase the separation between the equipment and receiver.
- Connect the equipment into an outlet on a circuit different from that to which the receiver is connected.
- Consult the dealer or an experienced radio/TV technician for help.

Note:

The unit's power supply is secondarily connected. Note following. The unit is not completely disconnected from the mains as long as the power cord is connected to a wall outlet.

Observera:

Apparatens strömförsörjning kopplas från sekundärt. V.g. ge akt på följande.
Apparaten frånkopplas inte helt och hållet från strömnätet medan apparatens nätsladd är ansluten till växelströmsuttaget.

Huom:

Virta yksikköön on kytketty pois sekundaaripuolelta. Huomioi seuraava.
Tämä yksikkö ei ole kokonaan kytketty pois pää virranjakajasta kun pää katkaisin on liitetty virtatiiriin.

Bemærk:

Strømmen til apparatet afbrydes på den sekundære side. Vær opmærksom på følgende.
Denne enhed er ikke fullstendig koblet fra lysnettet så længe stikket er tilsluttet stikkontakten.

Anmerkning:

Strømmen til apparatet er slått av på sekundærsiden. Vær oppmerksom på det følgende.
Dette apparatet koples ikke fullstendig fra nettet så lenge støpselet står i en stikkontakt, selv om strømbryteren settes i av-stilling.

System connections

Make connection as shown below. When connecting the related system components, refer also to the instruction manuals of the related components.

Do not plug in the power lead until all connections are completed.

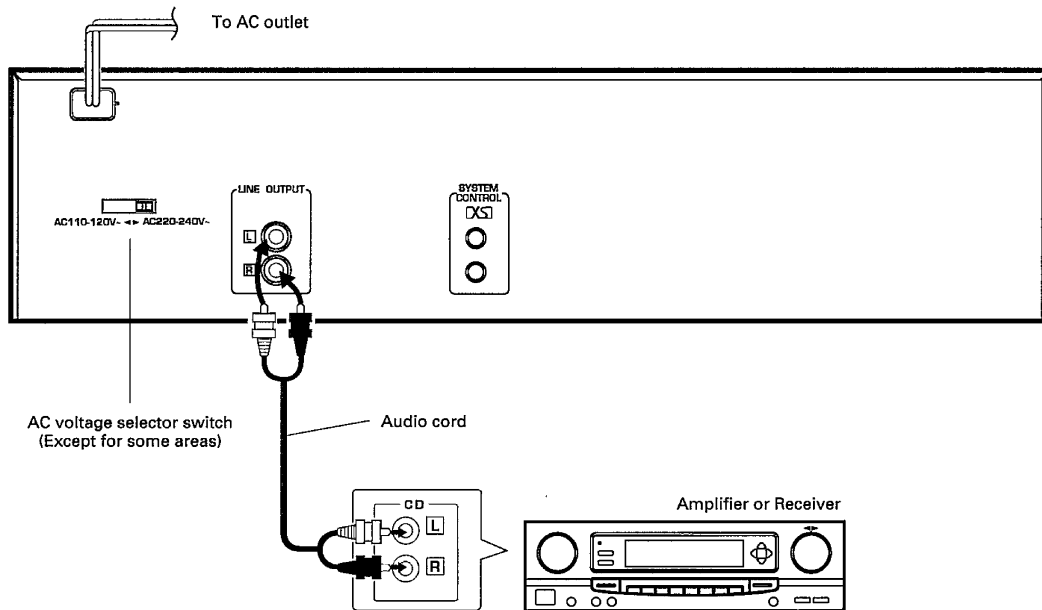

Notes:

1. Connect all cords firmly. If connections are loose, there could be loss of sound or noise produced.
2. When plugging and unplugging connection cords, be sure to first remove the power cord from the AC outlet. Plugging/unplugging connection cords without removal of the power cord can cause malfunctions or damage to the unit.

System control connection

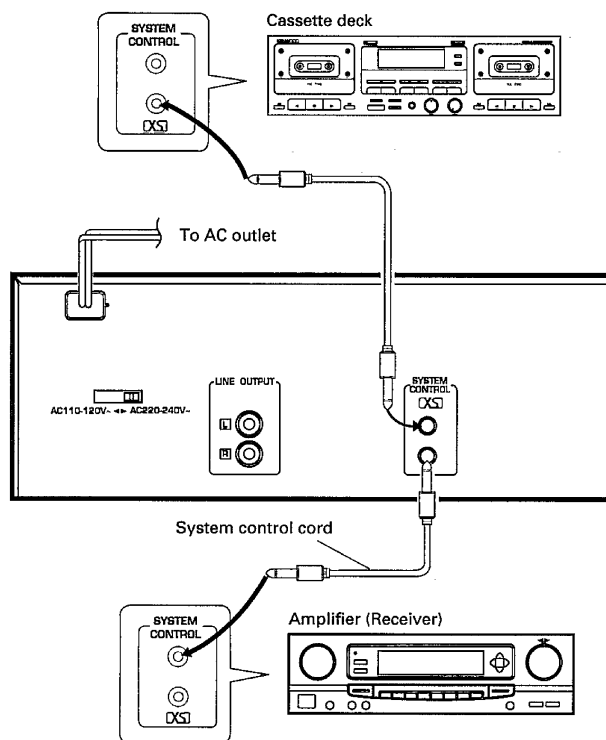

One System control cord is supplied with this unit.

When connecting more than one component for System control operation, use the System control cords provided with the other components.

System control connection

When connected to an amplifier or receiver having KENWOOD SYSTEM CONTROL terminals, system operation such as remote control is made possible. For details, refer to the instruction manual of the amplifier or receiver.

If your amplifier or receiver is not equipped with the SYSTEM CONTROL terminals, do not connect anything to any SYSTEM CONTROL terminal.

Do not connect the unit in any system configuration other than specified.

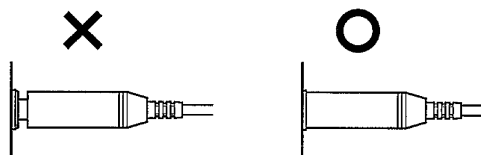

- Be sure to insert the system control cord plugs fully into the SYSTEM CONTROL terminals.
- If the system control cords and audio cords are not connected properly, the automatic system governing remote control and system functions will not operate.

CCRS

By connecting the SYSTEM CONTROL terminal of this unit with the "XS" SYSTEM CONTROL terminal of a KENWOOD cassette deck, CCRS recording can be carried out.

The CCRS function is used when recording from a CD to a tape in a cassette deck, and operates to adjust the cassette deck's recording level to the optimum setting according to the playing level of the CD.

For details on the CCRS function, refer to the instruction manual provided with your cassette deck.

Controls and indicators

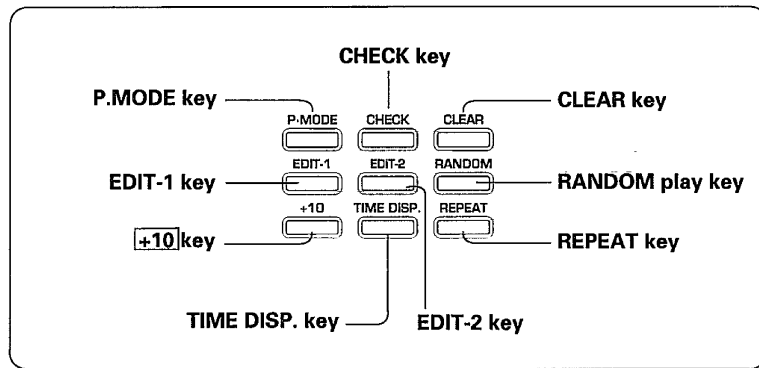
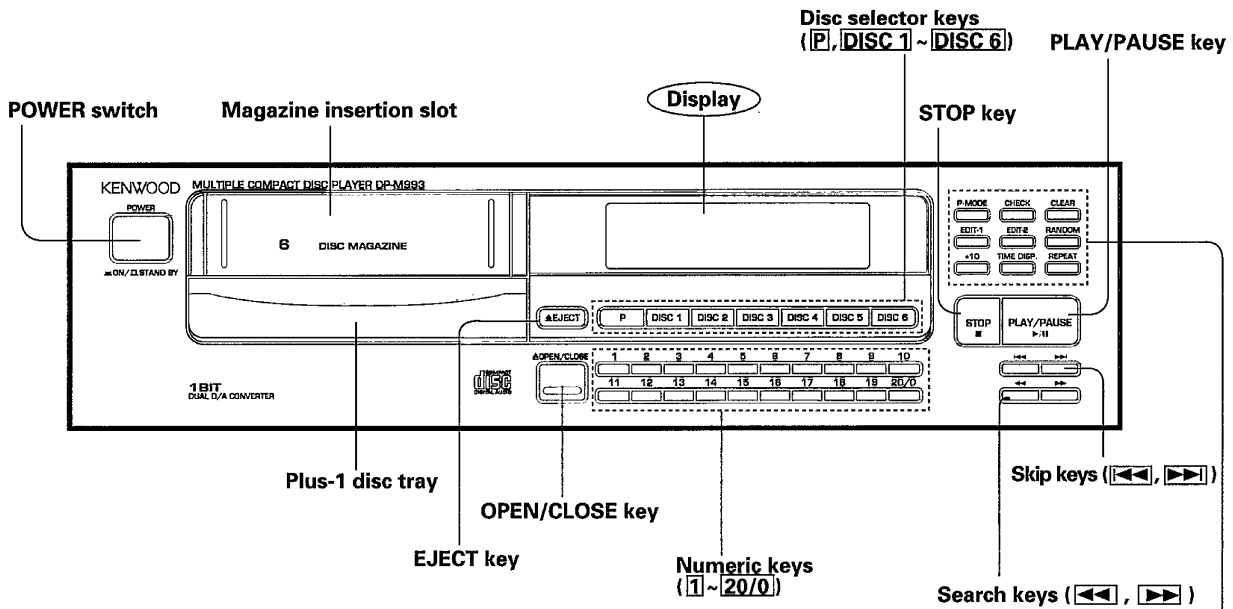

Display window

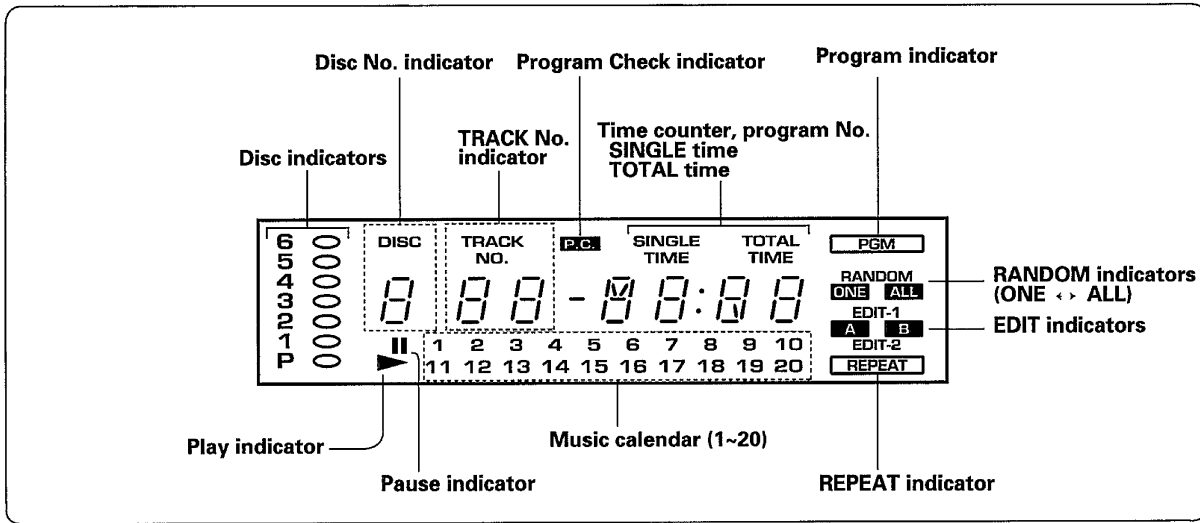

Before playing CDs

■ Loading a disc into the magazine

1 Pull out the disc tray.

① While pressing in on the lock button

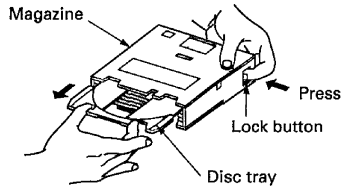

② Pull out the disc tray.

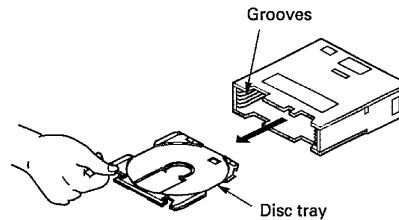

2 Place a disc on the disc tray.

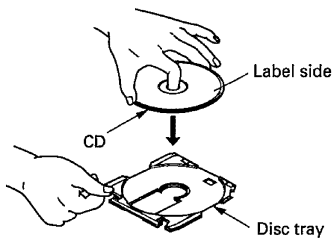

- Commercially-available CD single (8 cm) disc adapters cannot be used in this system. To play CD single (8 cm) discs, use the optional CDM-608 CD single magazine.

3 Insert the disc tray into the magazine.

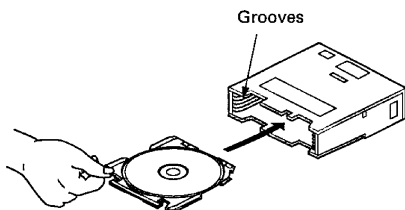

Align the tray with the corresponding left and right grooves and insert horizontally into the magazine.

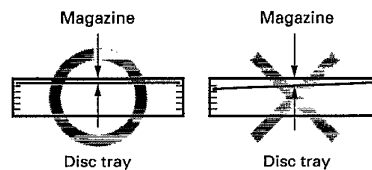

- Be sure to place each disc on a disc tray before inserting into the magazine.
- Even when loading fewer than six discs, make sure there are six disc trays inserted in the magazine during use.
- Always hold the magazine level when carrying.

How to Use Labels

Be sure to put the labels in the designated place. Placement of the label or tape in the wrong place may cause a malfunction.

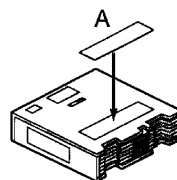

Labeling example:

A: Title of magazine

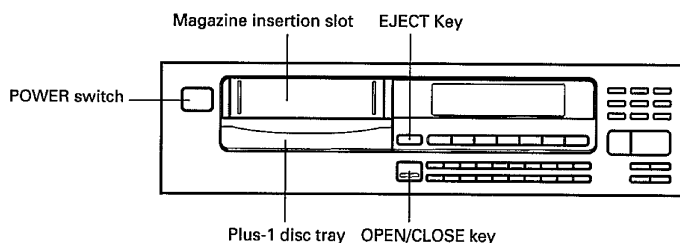

■ Loading a magazine

- 1 Press the POWER key to ON.

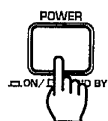

- 2 Insert the magazine.

①

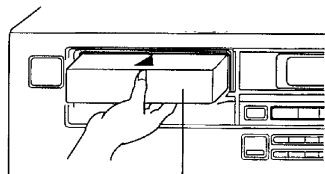

Magazine

②

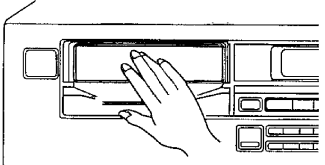

Press in until it locks in place with a click.

■ Removing a magazine

- 1 Press the POWER key to ON.

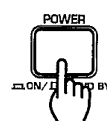

- 2 Remove the magazine.

- ① Press the eject key.

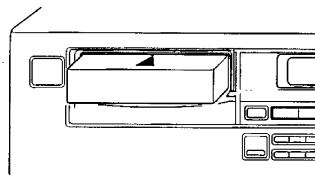

- ② Pull out the magazine.

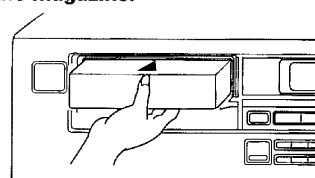

Hold the magazine in the center.

■ Loading a disc in the plus-1 disc tray

- ① Open the plus-1 disc tray.



- ② Place a disc on the tray.

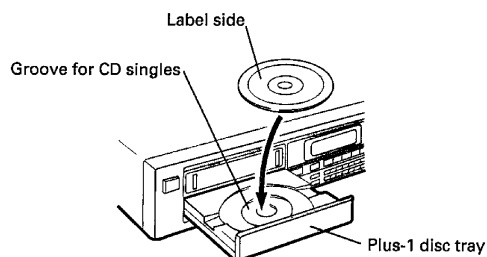

- ③ Close the plus-1 disc tray.



Normal playback

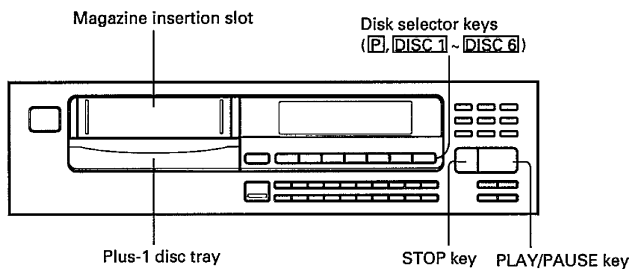

■ Playing a CD from the beginning

1 Place a disc in the magazine or on the plus-1 disc tray.

(Refer to pages 12, 13.)

All disc indicators light regardless of how many discs are in the magazine.

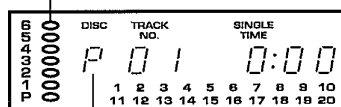

Plus-1 disc

2 Start playback.

Select the desired disc.

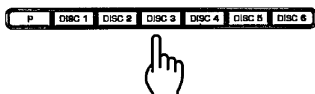

If there is no disc in the selected disc tray, the corresponding indicator goes out.

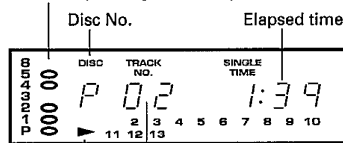

TRACK No.
Lights up.

- Playback starts from the selected disc. If two or more discs are loaded, the discs are played in order of their disc numbers.
- If the play key is pressed without selecting a disc, the discs will be played automatically in the following order: P → 1 → 2 → 3 → 4 → 5 → 6. (P: Plus-1 disc tray)
- To play a single disc only, remove the magazine and place a disc only in the plus-1 disc tray.

To pause playback

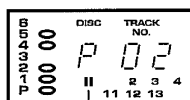

Lights up.

To resume playback, press the key again.

To stop playback



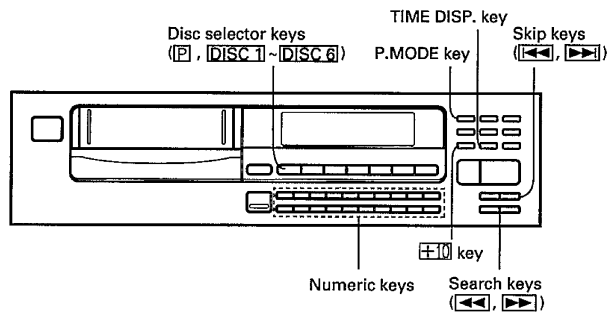

■ Listening from the desired track

1 Make sure the PGM indicator is extinguished.

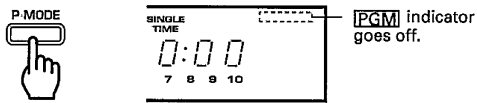

- If the PGM indicator is lighted, press the P.MODE key.

2 Select the desired disc.

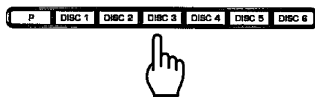

3 Select the desired track.

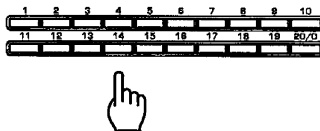

Examples of input

Track No. 11: **11**

Track No. 20: **20/0**

Track No. 30: **+10 +10 +10 20/0**

- Play starts from the selected tune and after.

To skip tracks

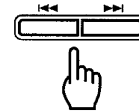

- The tunes are skipped in the direction of the key and the play starts at the beginning of the selected tune.
- When the skip backward key (left arrow) is pressed once during play, the track starts again from the beginning. (If pressed again, the play position returns to the preceding track.)

To fast forward and backward

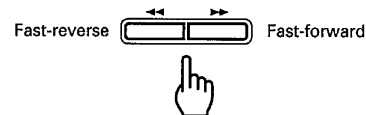

- The track will start to play from where you release the key.

TIME DISP. key

Press the TIME DISP. key when you want to check the elapsed time and remaining time of the track being played. Every time the TIME DISP. key is pressed, the displayed time changes as shown below. The time information display may not appear when playing a CD containing 21 or more tracks. In such a case, the display (remaining SINGLE TIME) will show "-----".

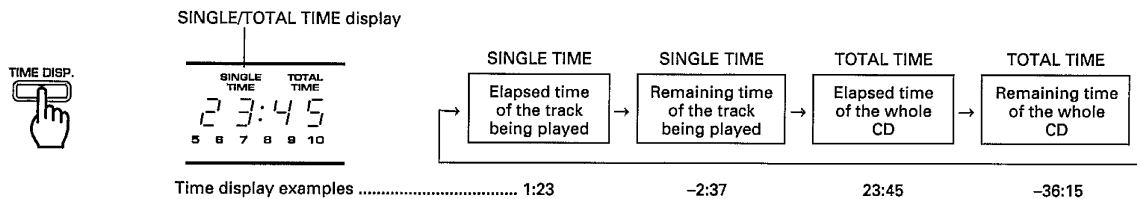

Program playback

The program mode allows you to play desired tracks of 7 discs in the order you want to listen to. A maximum of 20 selections can be entered in memory.

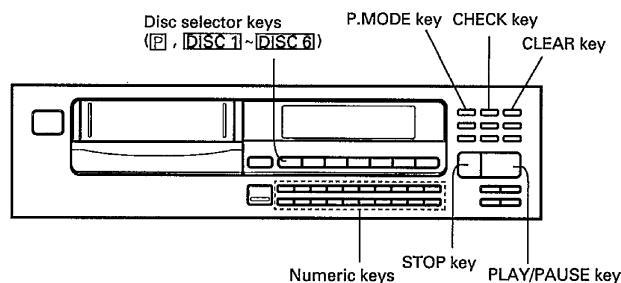

■ Playing desired tracks in desired order (PGM mode)

1 Enter the PGM mode.

Press the **P.MODE** key.

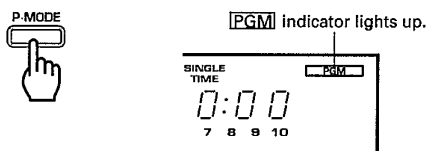

2 Program desired tracks in desired order.

Example

To select track no.5 on disc 4:

① Select the disc.

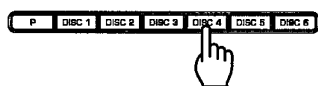

② Select the track.

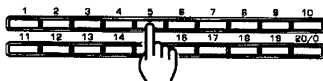

- Repeat steps ① and ② to program up to 20 tracks. After 21 or more tracks are selected, "--P--" is displayed.

To program all tracks on a disc:

Omit step 2-②.

- If more than eight seconds elapse before proceeding to step 2-②, all tracks on the selected disc will be programmed.

If you make a mistake during entry:

Press the **CLEAR** key and re-enter the correct number.

3 Start playback.



- Tracks are played in the order they are programmed (P-No.).
- If one of the skip keys (▶▶ or ◀◀) is pressed during programmed playback, the track being played is skipped in the forward or reverse direction.

To check the programmed order

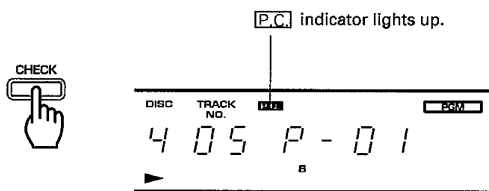

- Every time the **CHECK** key is pressed, the track No., DISC No. and the order it was programmed (P-No.) are displayed in the order of programming.
- The previous display will resume in a few seconds.

To resume normal playback

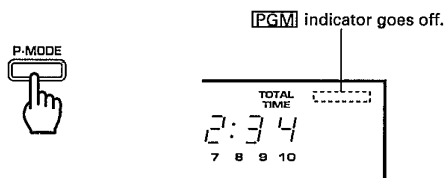

- The playback in the order of the track Nos. on CD will start after the track being played.

To stop programmed playback



Note:

If the magazine does not contain a disc corresponding to the disc No. selected in step 2-①, the disc and track are programmed but canceled at the time of playback.

■ To add a track to the program

Select the track No. to be added.

① Select the disc.



② Select the track number.

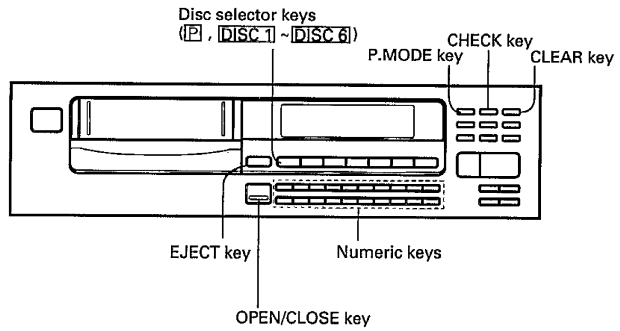

■ To change a track in the program

1 Press the CHECK key.

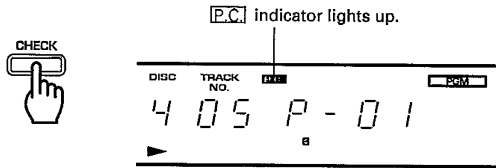

Press until the P.No. to be changed is displayed.

2 Select the track No. to replace the previous one.

① Select the disc.

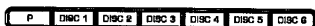

② Select the track number.



Press while the **P.C.** indicator is lighted.

- The track being played cannot be changed.

■ To clear tracks from the program

Clearing from the last track



- Every time the key is pressed, tracks are cleared from the last track in order.
- The currently playing track cannot be deleted.

Clearing the whole of program

Press any one of these keys.



Auto-Space function

In the program mode, a space of about 4 seconds is inserted automatically between the programmed tracks. This function is provided to facilitate the DPSS function of the cassette deck. However, such a space may also be inserted in case the sound of two tracks are continued, for example with some classic music and live recordings.

Repeated playback

■ Repeated playback

Repeated playback of programmed tracks

1 Enter the PGM mode.

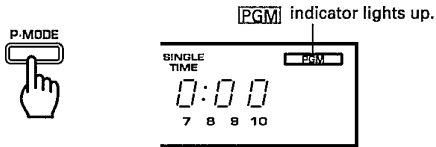

2 Select the desired track(s).

(Refer to page 16.)

① Select the desired disc.

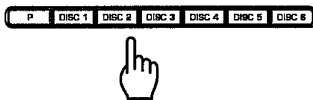

② Select the desired tracks.

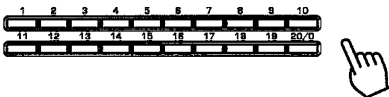

- When you want to repeat only one track, go to step 3 below.
- Repeat steps ① and ② to program up to 20 tracks.

3 Press the REPEAT key.

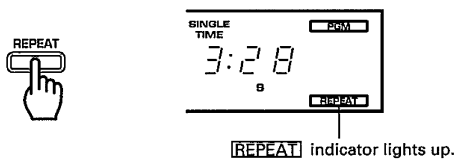

4 Start playback.



- All of the selected tracks will be played repeatedly.
- If only one track is selected, that track will be played repeatedly.

Repeated playback of the whole CDs

1 Make sure the PGM indicator is extinguished.

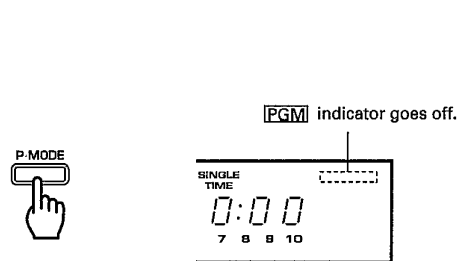

- If the PGM indicator is lighted, press the P-MODE key.

2 Press the REPEAT key.

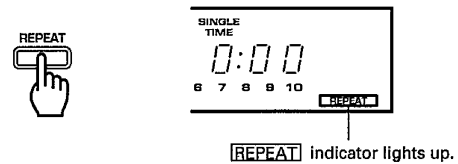

3 Start playback.



- All tracks on all discs in the magazine and Plus 1 tray will be played repeatedly.

To resume normal playback

Press the REPEAT key again.

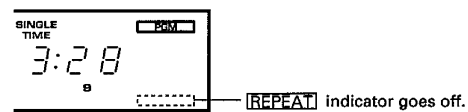

- The playback will be resumed under the CD player mode set before the repeat.

Random playback

This function allows for random selection of the tracks each time and continuous playing in any order. It lets you enjoy hours of tireless track listening.

■ Playing tracks in a random order

1 Make sure the PGM indicator is extinguished.

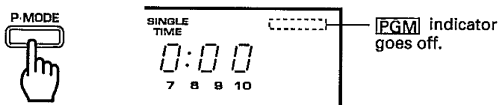

- If the PGM indicator is lighted, press P.MODE key.

2 Select the desired random mode.

To randomly play a single disc

① Select the disc.



To randomly play all discs

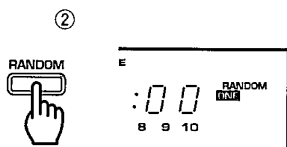

Select RANDOM **ONE**.

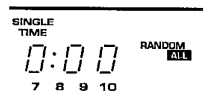

Select RANDOM **ALL**.

Each press changes the random mode as shown below.

→ RANDOM **ONE** → RANDOM **ALL** → Goes off.

- Tracks on one disc are selected in a random order and played.

- Tunes are selected and played at random from all of the discs.

Display when track 7 of disc 3 is selected first

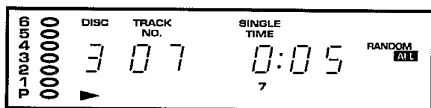

- When one tune ends, the next tune is randomly selected and played.

Display when track 3 of disc 5 is selected next

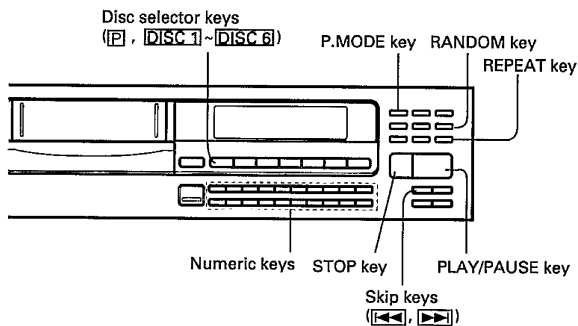
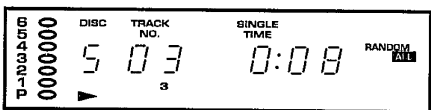

To select another track during random play

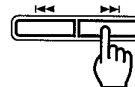

- When the skip key is pressed once during random play, the track starts again from the beginning.

To cancel random play

Press to off.



or

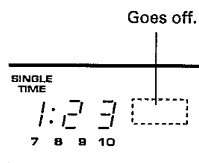

Each press changes the random mode as shown below.

RANDOM **ONE** → RANDOM **ALL**
 Goes off.

- Normal play starts from the track being played.

- Playback stops.

Note:

The same track will not play twice over continuously, however, it may happen that the same track is repeated later in play.

Editing

When recording tunes from one or more CDs onto a tape, this function edits the tunes to ensure that the tunes fit within the specified tape length and that the last tune on either side does not get cut off in the middle. Two edit keys, EDIT-1 and EDIT-2, allow you to edit two different discs separately. This is convenient for times when you want to record two tapes in succession.

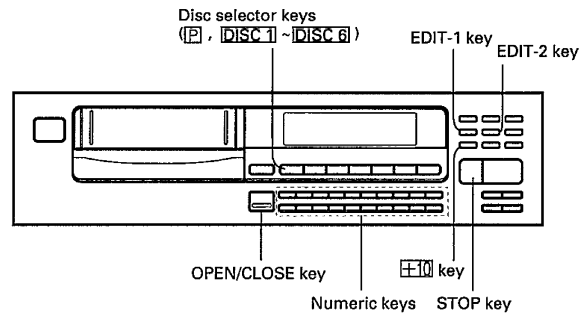

■ To edit a disc

1 Press the STOP key.

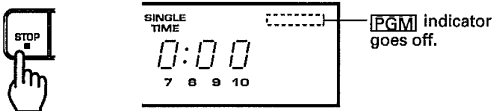

- Make sure the **PGM** indicator is extinguished.

2 Press the EDIT-1 key.

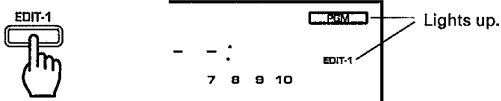

- You cannot use the **EDIT-2** key until the first disc has been edited using the **EDIT-1** key.

3 Select the disc you want to edit.

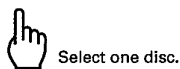

Select one disc.

- Editing using two or more discs at one time is not possible.

4 Enter the tape length.

Example

For C-46: **+10 +10 +10 +10 6**

For C-30: **+10 +10 +10 20/0**

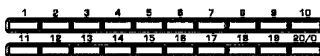

Editing is carried out as follows.

- (1) The specified tape length is divided in half, then as many tunes as will fit in the A file (side A of the tape) are selected starting with the small track numbers.

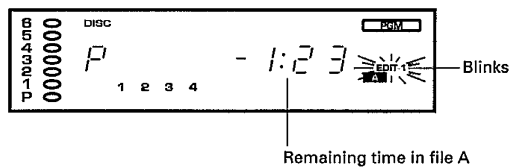

Remaining time in file A

- (2) After a few seconds the remaining time left in the A file appears on the display, then the B file (side B of the tape) is edited in the same manner.

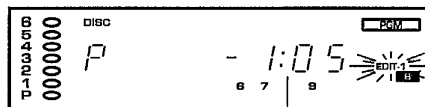

Remaining time in file B

- If you press the **STOP** key or **OPEN/CLOSE** key while editing is being carried out, editing is interrupted and stops.

Editing completed

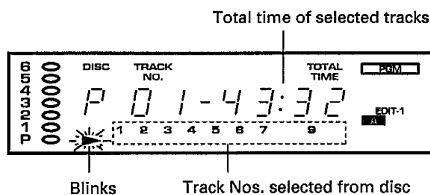

Blinks

Track Nos. selected from disc

To edit a second disc

Press the **EDIT-2** key in step 2, then perform steps 3 and 4 in the same manner as for the first disc.

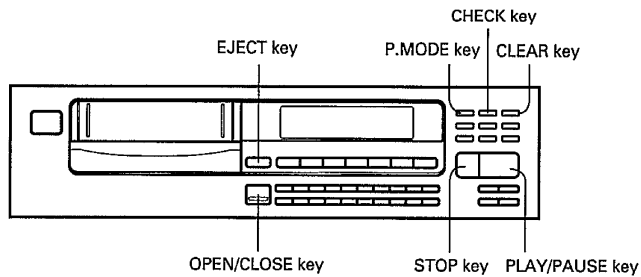

■ To check the edited program contents

Press the CHECK key.

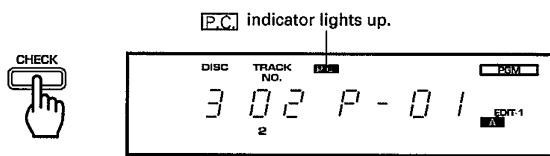

- Every time the CHECK key is pressed, the track Nos. are displayed in the edited order.

■ To play an edited program

① To play the A file:



The tunes in the A file are played in sequence and the player enters pause mode at the beginning of the B file.

② To play the B file:



To play the second disc (EDIT-2):

Repeat steps ① and ② above.

- Playback stops after having played the B file.

■ To record an edited program

The CCRS recording function may be used by connecting the CD player to any KENWOOD cassette deck with an "XS" mark, using a system control cord. If connected to a cassette deck that is able to relay recording, material edited using the EDIT-1 and EDIT-2 keys can be continuously recorded. For details please refer to "Recording of CD playback" section in your cassette deck instruction manual.

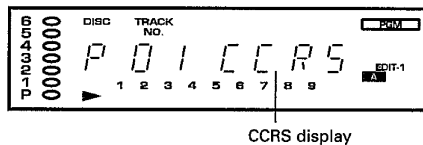

■ To erase the edited contents

Press any one of these keys.

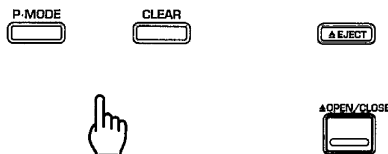

- The whole of the edited contents are cleared.

Notes:

1. While you can edit with a different time setting to that of the tape you are using, part of the tape may be left with nothing recorded on it, or the last track on side A or side B may be cut short.
2. Up to a maximum of 20 tracks can be edited using this function.
3. The EDIT function may not operate properly for discs having only one track or having tracks of long duration such as classical music.

Timer operations

This unit incorporates a built-in timer standby function. By using an audio timer optionally available in the market, wake-up playback can be started at any time of the day.

Preparations for timer playback

Connect the power cords of the components to the timer so that their powers can be turned on via the timer.

Read carefully the instruction manual of your audio timer.

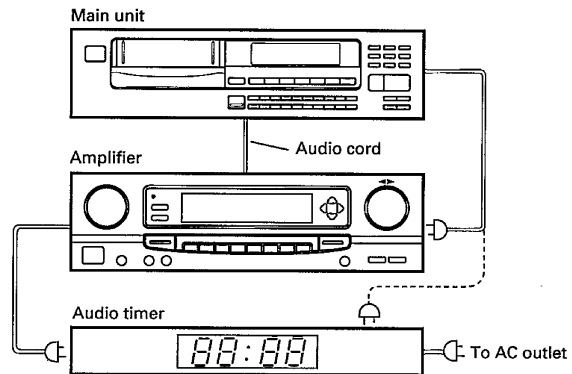

■ Timer playback

1 Set the power switches of the components to ON.

2 Place a disc in the magazine or on the plus-1 disc tray.
(Refer to page 13.)

3 Set the amplifier volume.

- ① Start playback.
- ② Adjust the volume of the amplifier.
- ③ Stop playback.

4 Set the timer at the desired time of the day.

- Read carefully the instruction manual of your audio timer.
- When the set time comes, playback starts automatically.

When operating the unit other than CD player using an audio timer, be sure to remove the disc or the magazine from the CD player.

In case of difficulty

What appears to be a malfunction may not always be serious. If your unit should not perform as expected, consult the table below to see if the problem can be corrected before seeking help from your dealer or service representative.

Symptom	Cause	Remedy
No power is applied with the POWER switch ON.	<ul style="list-style-type: none"> ● Power plug is loosely connected. ● With the power plug connected to the switched AC outlet of an amplifier, the power of the amplifier is turned off. 	<ul style="list-style-type: none"> ● Insert the power plug firmly into the AC outlet. ● Turn the amplifier's power ON.
Disc is loaded, player does not play.	<ul style="list-style-type: none"> ● Disc is loaded upside down. ● Disc is loose. ● Disc is dirty. ● Disc is cracked. ● Condensation occurred on the optical lens unit. 	<ul style="list-style-type: none"> ● Load the disc again with its label side up. ● Insert the disc properly. ● Wipe off the dust on the surface of the disc referring to "Disc handling precautions". ● Replace the disc with a new one. ● Leave the player for about 1 hour so that the condensation is removed.
No sound.	<ul style="list-style-type: none"> ● Disc is not loaded. ● Play mode is not entered (The play/pause indicator is not lit.) ● Disc is too dirty. ● Disc is cracked. ● The connection cords are inserted loosely. 	<ul style="list-style-type: none"> ● Load a disc. ● Press the [▶/II] key. ● Wipe off the dust on the disc surface referring to "Disc handling precautions". ● Replace the disc with a new one. ● Connect all connection cords firmly.
Music is interrupted. (Sound is skipped.)	<ul style="list-style-type: none"> ● Disc is too dirty. ● Disc is cracked. ● Oscillation is applied to this unit. 	<ul style="list-style-type: none"> ● Wipe off the dust on the disc surface referring to "Disc handling precautions". ● Replace the disc with a new one. ● Try selecting a place where no strong vibrations occur by changing the installation place, etc.
Play begins as soon as the power is turned on.	<ul style="list-style-type: none"> ● This unit is designed so that play begins automatically when the power is turned on if a disc or a magazine is already loaded. 	<ul style="list-style-type: none"> ● If automatic play is not required, remove the disc or the magazine from the player before turning the power OFF.

Notes:

1. This system is microprocessor-controlled, so malfunction may occur due to external noise or interference noise. In such a case, unplug the power cord, plug it and turn power on again.
2. Do not use contact cleaners because it could cause a malfunction. Be specially careful against contact cleaners containing oil, for they may deform the plastic components.

Specifications

[Format]

System Compact disc digital audio system
 Laser Semiconductor laser
 Number of channels 2 channels
 playing rotation 200 rpm ~ 500 rpm (CLV)

[D/A Converters]

D/A conversion 1 Bit
 Oversampling 8 fs

[Audio]

Frequency response 8 Hz ~ 20 kHz ± 1.0 dB
 Signal to noise ratio More than 96 dB
 Dynamic range More than 94 dB
 Total harmonic distortion
 Less than 0.005% (at 1 kHz)

Channel separation More than 90 dB (at 1 kHz)
 Wow & flutter Unmeasurable limit
 Output level/impedance
 Fixed 2.0 V/3.3 kΩ

[General]

Power consumption 15 W
 Dimensions W: 440 mm (17-5/16")
 H: 119 mm (4-11/16")
 D: 360 mm (14-3/16")
 Weight (net) 5.1 kg (11.2 lb)

Note:

KENWOOD follows a policy of continuous advancements in development. For this reason specifications may be changed without notice.

KENWOOD